

**BRCF1960SL/W**  
**Frost Free Fridge**  
**Freezer**

**INSTRUCTION MANUAL**

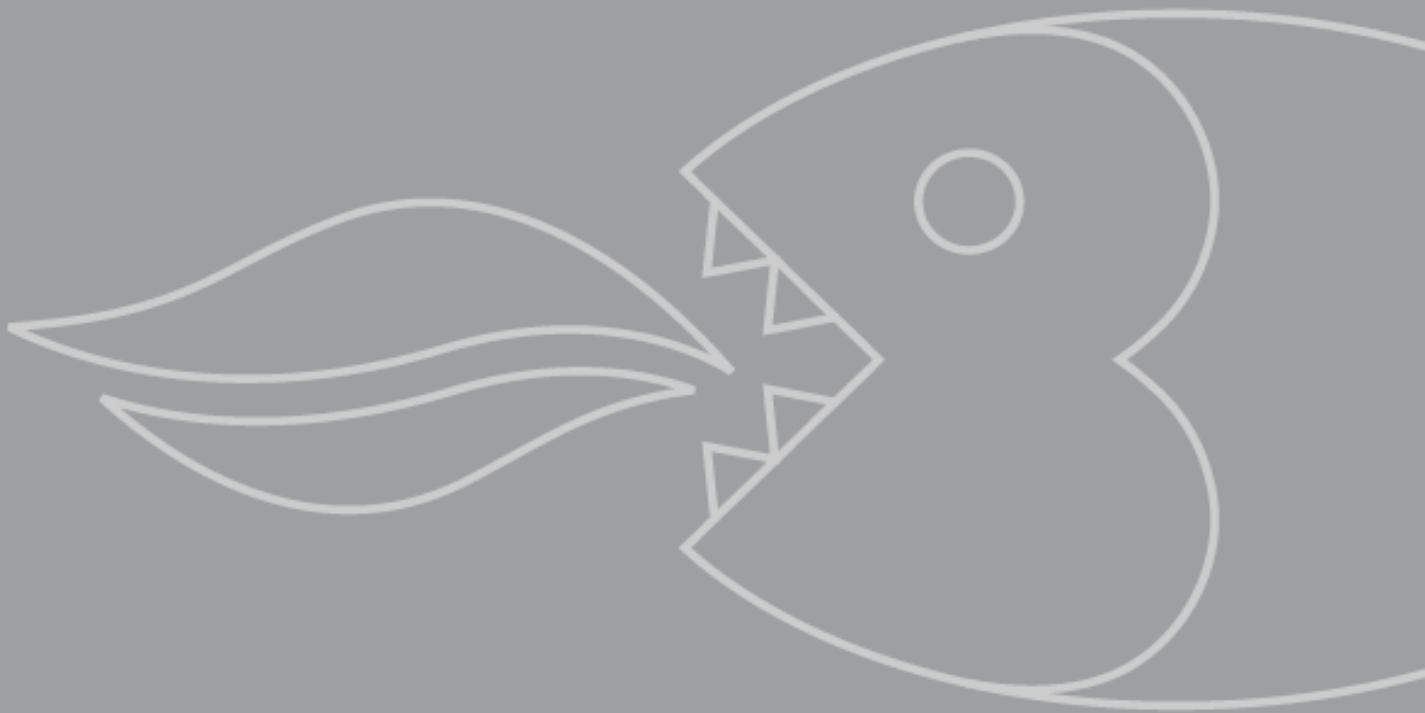

# USER MANUAL FOR YOUR BAUMATIC

## **BRCF1960SL/W** Frost free fridge freezer



***NOTE: This User Instruction Manual contains important information, including safety & installation points, which will enable you to get the most out of your appliance. Please keep it in a safe place so that it is easily available for future reference, for you or any person not familiar with the operation of the appliance.***

# Contents

<b>Environmental note</b>	4
<b>Important safety information</b>	5 – 7
<b>Specifications of your fridge freezer</b>	7 – 9
Description of the appliance	8
Description of the product features	9
<b>Using your Baumatic fridge freezer</b>	10 - 16
Before switching on	10
During first use	10
Switching on the appliance and setting the thermostat	11
Arranging and storing food in the fridge section	12 - 13
The  freezer compartment	13
Freezing fresh food	13 - 14
Tips on freezing	14
Storing commercially frozen food	14 - 15
Defrosting frozen food	15
Making ice cubes	15
Normal operating noises	15 - 16
<b>Saving energy when using your fridge-freezer</b>	16 - 17
<b>Cleaning and maintenance</b>	17 - 20
Replacing the light bulb	18 - 19
The defrost drain hole	19
Defrosting the freezer compartment	19 - 20
<b>Installation</b>	21 - 24
Electrical connection	21 – 22
Reversing the door swing	22 - 23
Positioning	23 - 24
<b>Troubleshooting</b>	24 – 26
<b>Baumatic consumables</b>	27
<b>Technical data</b>	28
<b>Contact details</b>	29

## Environmental note

***Note: Before discarding an old appliance, switch off and disconnect it from the power supply. Cut off and render any plug useless. Cut the cable off directly behind the appliance to prevent misuse. This should be undertaken by a competent person. Disable the door lock to make sure that children cannot get stuck inside the appliance.***

**This appliance is marked according to the European directive 2002/96/EC on Waste electrical and Electronic Equipment (WEEE). By ensuring this product is disposed of correctly, you will help prevent potential negative consequences for the environment and human health, which could otherwise be caused by inappropriate waste handling of this product.**



**The symbol  on the product, or on the documents accompanying the product, indicates that this appliance may not be treated as household waste. Instead it shall be handed over to the applicable collection point for the recycling of electrical and electronic equipment.**

**Disposal must be carried out in accordance with local environmental regulations for waste disposal.**

**For more detailed information about treatment, recovery and recycling of this product, please contact your local city office, your household waste disposal service or the shop where you purchased the product.**



- The packaging materials that Baumatic uses are environmentally friendly and can be recycled.
- Please discard all packaging material with due regard for the environment.

## Important safety information



Your safety is of the utmost importance to Baumatic. Please make sure that you read this instruction booklet **before** attempting to install or use the appliance. If you are unsure of any of the information contained in this booklet, please contact the Baumatic Customer Care Department.

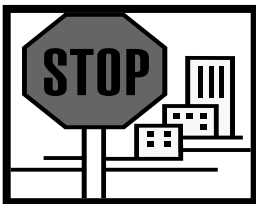

***IMPORTANT: Any installation work must be carried out by a qualified electrician or competent person.***

### Use of the appliance

- Your appliance is only designed to be used in the home. It is suitable for storing food that needs to be chilled and refrigerated. If it is used for any other purpose or it is not used correctly, then Baumatic Ltd. will accept no liability for any damage that is caused.
- Altering the specification of the appliance must not be attempted for reasons of safety.



### Before using your appliance

- Check the appliance for any signs of transport damage. If you notice any damage, then you should not connect your appliance to your mains supply and should contact your retailer.

### Refrigerant

- Your appliance contains R600a refrigerant, which is a natural gas that does not contain CFCs that can damage the environment. However it is a flammable substance, therefore care should be taken:
  - During the transportation and installation of the appliance, make sure that the refrigeration pipework does not get damaged.
  - If it does become damaged then sources of ignition and open flames should be avoided. Also the room that the appliance is situated in should be thoroughly ventilated.

- Do not place any objects on top of the appliance, as this may damage the table top.



### Child safety

- Packaging material should be kept away from children.
- Children should not be allowed to touch the controls or play with the appliance.



### General safety

- Do not pull on the power supply cable to remove the plug from your mains supply socket.
- Do not pull out or insert the plug with wet hands.
- Do not attempt to use your appliance outdoors or any place where it is likely to come into contact with the elements.
- Before cleaning the appliance or performing maintenance work, ensure that the appliance has been disconnected from your mains supply.
- Never allow the back coils of the appliance to come into contact with the wall surface.
- Always ensure that the location where you are installing your appliance is free of stored items such as papers and other flammable materials.
- Never block the ventilation openings of the appliance, either on the inside or its exterior.
- It is vital to keep your appliance well ventilated, so that there is proper air flow between the bottom of the unit and the plinth/kick plate which it is sitting on.

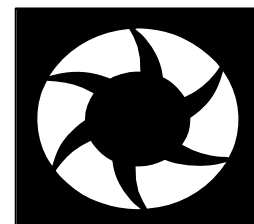
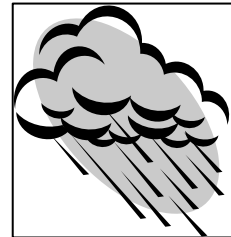

- Do not place electrical devices inside of the appliance, such as mixers or ice cream makers.

## Service

You should not attempt to repair the appliance yourself, as this could cause injury or a more serious malfunction. If you require a service call then please contact the Baumatic Customer Care Department.

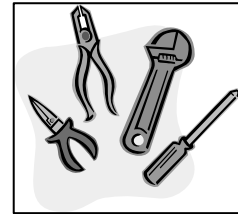

## Specifications of your fridge freezer

- Total gross/net capacity: 287 / 279 litres
- Gross capacity (fridge/freezer): 216 / 71 litres
- Net capacity (fridge/freezer): 210 / 69 litres
- Energy efficiency class: A+ (0.72 kWh per 24 hours)
- Freezer star rating: \*\*\*\*
- Freezing capacity (kg / 24 hour): 3.5 kg
  
- Adjustable thermostat in fridge section
- Automatic fridge defrost
- Frost free freezer
- 4 x Safety glass shelves (3 adjustable)
- 3 x Transparent freezer drawers
- Salad crisper shelf
- 1 x Salad crisper
- 1 x Bottle shelf
- 1 x Egg tray
- 3 x General door shelves
- Wine rack
- Reversible door
- Adjustable feet
- Internal light
- Ice-cube tray

## Dimensions of appliance

Height: 1935 mm  
Width: 604 mm  
Depth: 610 mm

***IMPORTANT:*** When you install your appliance it is important to bear in mind its climatic rating.

In order to find out the climatic rating of your appliance, you should check the rating plate. The rating plate is located on the front edge of the inside of the fridge section, behind the salad drawer. You will need to open the fridge door of your appliance to be able to find it. The rating plate will indicate the ambient temperature range that your appliance will function correctly within.

**Model number** .....

**Serial number** .....

**Date of purchase** .....

**Description of the appliance**

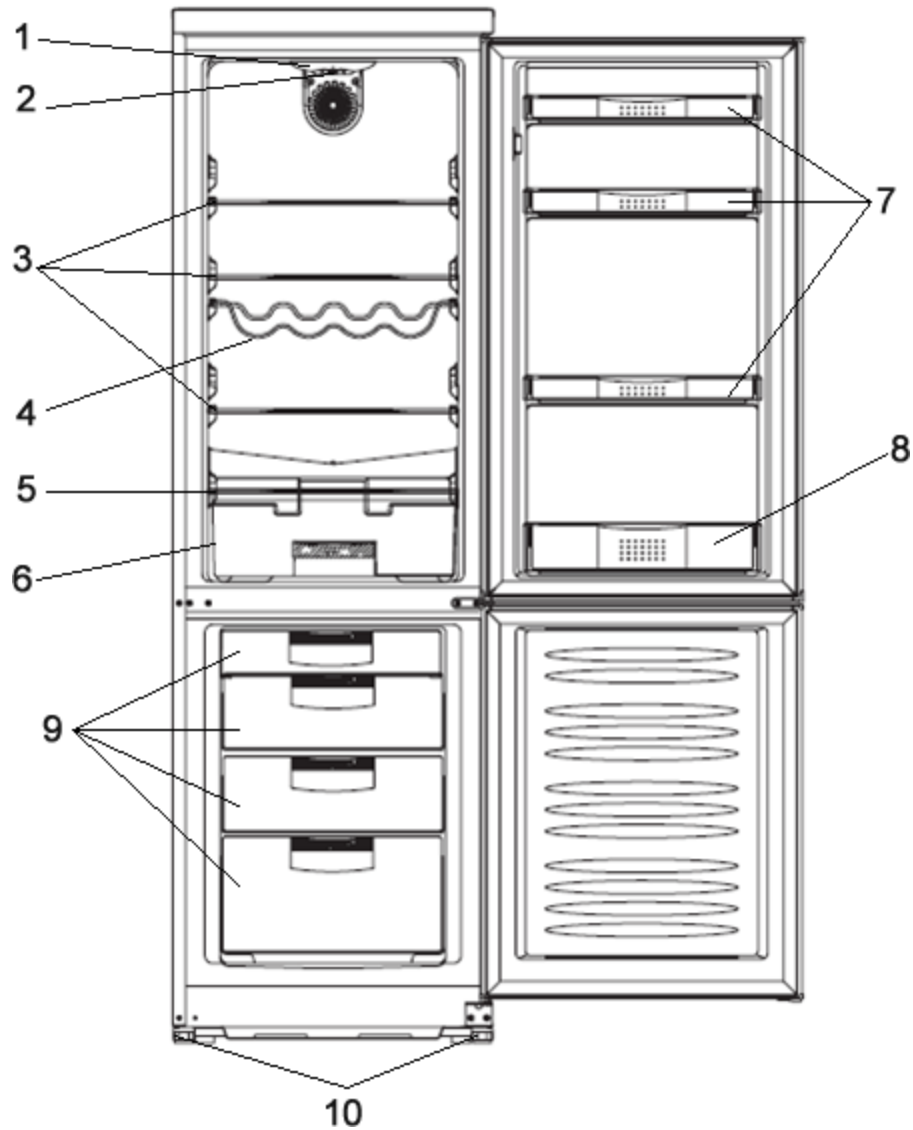

- 1) Internal light
- 2) Thermostat control dial
- 3) Adjustable safety glass shelves
- 4) Wine rack
- 5) Salad crisper shelf
- 6) Salad crisper
- 7) General door shelves
- 8) Bottle shelf
- 9) Transparent freezer drawers
- 10) Adjustable feet



## Description of the product features

### 1) Adjustable fridge shelves

- The shelves may be placed in any of the guide slots within the interior of the appliance. They are protected from sliding out.
- To remove a shelf: Take off all of the items that are stored on the shelf that you want to remove. Then lift the rear of the shelf slightly and carefully pull it forward, out of the grooves.

### 2) Salad crisper drawer and cover

- The crisper drawer is in the bottom of your refrigerator and there is a cover that goes over it.
- The cover helps to prevent fruit and vegetables from drying out prematurely.

### 3) Upper door shelves

- The door liner holds various shelves, which are suitable for storing eggs, cheese, butter and yogurt. As well as smaller packages, tubes, cans etc.

### 4) Bottle shelf

- The lower shelf should be used for storing reasonably sized bottles.
- ***IMPORTANT: IT IS IMPORTANT THAT NONE OF THE SHELVES THAT SIT IN THE DOOR ARE OVERLOADED, AS THIS WILL DRASTICALLY REDUCE THEIR WORKING LIFE.***

### 5) Freezer compartment

- A \*\*\*\* freezer section, with a net capacity of 69 litres.

## Using your Baumatic fridge freezer

### Before switching on

- Make sure that it has been installed by a suitably qualified person, as per the information contained in Baumatic's installation instructions.
- After delivery, wait for eight hours before connecting the appliance to your mains supply. This will allow any refrigerant gasses that may have been disturbed during the transportation process to settle.
- The outside of the appliance and the removable accessories contained within it, should be cleaned with a solution of liquid detergent and water.
- The interior of the appliance should be cleaned with a solution of sodium bicarbonate dissolved in lukewarm water. The interior and accessories should be thoroughly dried, after the cleaning process has been completed.
- There can be an odour when you first switch on the appliance. It will lessen as the appliance starts to cool.

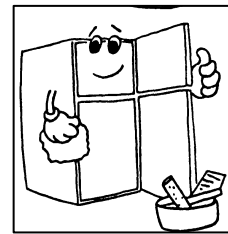

### During first use

- When you first switch on the appliance, the compressor will run continuously for approximately 24 hours or until the fridge freezer reaches a cool enough temperature.
- With dry hands, connect your appliance to your mains supply. Set the control dial to position 5 for a 24 hour period, before placing food in the fridge and freezer compartments.
- During this period of time, you should try not to open the door frequently or place a large amount of food within the appliance.
- It is strongly recommended that you use a freezer thermostat to check that the temperature in the freezer is below  $-18^{\circ}\text{C}$  before loading any food into it.
- If the unit is switched off or unplugged, you must allow at least 5 minutes before restarting the appliance on the thermostat or reconnecting it to your mains supply.

## Switching on the appliance and setting the thermostat

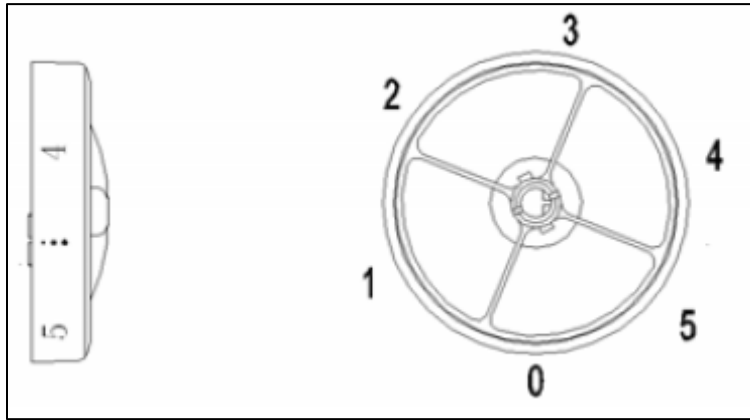

- You switch on your appliance by connecting it to your mains supply and setting the thermostat.
- The thermostat automatically regulates the temperature inside the fridge depending on what you have the control panel set to.
- The marks on the control dial indicate temperature grades, **NOT** the degrees of temperature. 0 is OFF and 5 represents the lowest temperature setting.
- It is recommended that the control dial is set to position 3 after the 24 hour cooling period. You should use a suitable thermometer to check the temperature after 2 hours to ensure the fridge is at the ideal temperature of between 3°C and 4°C.
- The freezer compartment temperature will vary between -18°C and -25°C during a typical cycle.
- **IMPORTANT:** *The ambient temperature of the room, the temperature of food and the amount of food that has been placed in the fridge freezer and how often the door is opened, will all affect the temperature being maintained by the appliance.*
- On the maximum setting your fridge freezer will work harder to maintain a lower temperature and will increase the energy usage. There is no need to run your appliance at this setting for prolonged periods. Unless you are freezing fresh food, you should have the digital thermostat set to 3.
- If the unit is switched off or unplugged, you must allow at least 5 minutes before restarting the appliance or reconnecting it to your mains supply.

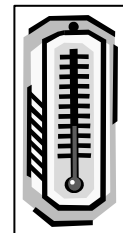

## Arranging and storing food in the fridge section

- Warm food or evaporating liquids should not be stored in your refrigerator, as this will increase the humidity inside of the appliance.
- All foods should be wrapped or covered, this is particularly important if the food has a strong flavour. You should use polythene bags or sheets, aluminium foil or wax paper. Liquids should be stored in covered containers or bottles.
- To maximise the space inside of the fridge section, any excessive packaging on the food should be removed.
- Quickly perishable food should be stored at the back of the refrigerator, which is the coldest part of the appliance.
- No food items should be allowed to come into contact with the back wall of the refrigerator.
- Make sure that you arrange food in such a way that the door can close completely. Particular attention should be given to bottles that may protrude when placed on shelves inside the main section of the refrigerator.
- Some organic solutions, such as the oils in lemon/orange peel and acid in butter, can cause damage to the plastic parts contained inside of the refrigerator.
- Do not open the refrigerator door too often or leave the door open for long periods of time, as this will increase the temperature inside of the appliance and will increase the energy usage.
- **Meat** should be wrapped in polythene bags and then placed on the glass shelf above the salad drawer.  
  
*(Meat should only be stored in this manner for one or two days at the most).*
- **Cold dishes/cooked food** should be covered and can be placed in the coldest area of the fridge.
- **Fruit and vegetables** should be cleaned thoroughly and placed in the salad drawer.
- **Cheese and butter** should be placed in airtight containers, or they can be wrapped in aluminium foil or polythene bags. As much air as possible should be removed from the bags.

- **Milk bottles** should have a cap on them and be stored on the bottle shelf that sits in the door.
- **Garlic, potatoes, onions and bananas should only be stored in a refrigerator IF they are kept in airtight containers.**

## The \*\*\*\* freezer section

The freezer section is suitable for storing and freezing food.

- The freezer section temperature must have already reached -18 degrees centigrade (or lower) before you attempt to store food that is already frozen or freezing fresh food.
- The freezer section is only able to freeze a certain quantity of food at one time. You should not attempt to freeze more than 3.5 kilograms of fresh food within a 24 hour period.
- Any of the drawers can be used for freezing various foods.
- Warm food should be allowed to cool down before you attempt to freeze it. If you place warm food in the freezer section, then the increased humidity will cause quicker ice formation and increase the amount of power that the appliance uses.
- The guidance of the food manufacturer should be followed, in regard to the maximum storage time.
- Thawed foods must not be frozen for a second time.
- If power is cut to your appliance, DO NOT open the door to the freezer section. Your freezer will store food safely for approximately 10 hours.
- **IMPORTANT:** *If the food has started to defrost before power is restored, then DO NOT re-freeze the items. The food should be used within a relatively short period of time.*

### Freezing fresh food

- Fresh food should be packed into airtight containers or packaging. This will help to make sure that the food doesn't dry out or lose its flavour. It will also ensure that flavour does not transfer from other foods.

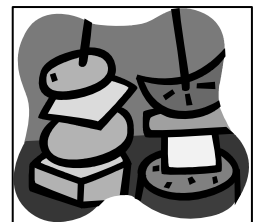

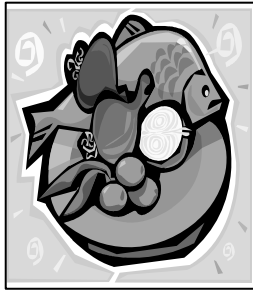

- Do not allow fresh food to touch items that are already frozen.

- Chill fresh food in the fridge before freezing if possible.

### Tips on freezing

- Freezer bags, polythene wraps, aluminium foil (extra thick) and special cans for frozen foods are suitable packaging for storing frozen goods in.
- Tape, rubber bands or plastic clips are suitable for sealing bags and wrappings.
- Before sealing a suitable bag, you should compress the air out of it, as this will help the food to freeze more easily.
- Flat packages freeze more easily.

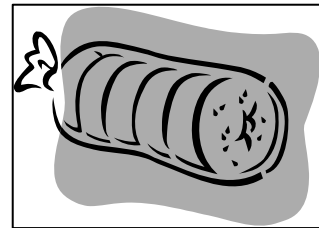

- If you are freezing liquid, then do not fill the container to the brim. Liquids will expand when being frozen.
- ***Do not place bottles (glass or tin) containing liquids (especially sparkling liquids) into the freezer as they could cause the bottle to burst during freezing.***

### Storing commercially frozen food

- The storage time and recommended temperature for storing commercially frozen foods are indicated on the packaging.
- Always follow the manufacturer's instructions for storage and use of frozen food.
- When shopping, be careful to choose food which is adequately packed and is provided with complete storage instructions. It should have been stored in a freezer where the temperature does not rise above  $-18^{\circ}\text{C}$ .

- Do not buy packages of food that are covered with frost. This could indicate that the package has thawed at least once before.
- Take care that your frozen food packages do not start to thaw before you place them in your freezer. This will shorten the length of time that you can safely store the food for.

### **Defrosting frozen food**

- Partially thawed or defrosted foods should be used as soon as possible.
- Cold air preserves the food but it does not destroy the micro organisms which rapidly activate themselves after defrosting and make foods perishable.
- Partial defrosting reduces the nutritional value of food, especially fruits, vegetables and readymade meals.

### **Making ice cubes**

- Fill the ice cube tray with water and place it in the upper freezer drawers.
- After the water is completely frozen and turned to ice, you can twist the ice cube tray (as shown in the drawing below) to dispense the ice.

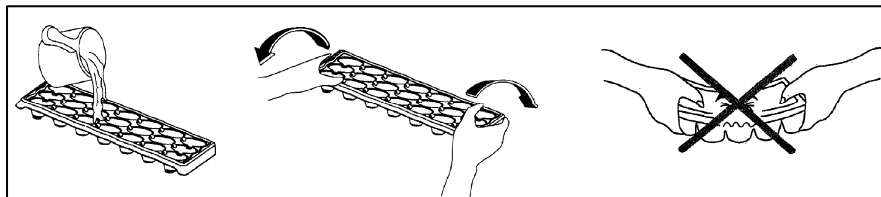

### **Normal operating noises**

#### **Ice cracking noise**

- Can be heard during the automatic defrosting process.
- Can be caused by expansion and contraction within the fridge freezer.

#### **Short cracking noise**

- Can be heard when the thermostat turns the compressor on and off.

## **Compressor noise**

- There will be an operating noise when the compressor is running.
- After installation, the compressor may be noisier for a short period of time.

## **Bubbling and burbling sound**

- This noise is emitted as the coolant flows through the pipework within the fridge freezer.

## **Water flowing sound**

- This is caused by water flowing into the evaporating tray during the defrosting process and can be heard whilst the fridge freezer is defrosting.

## **Saving energy when using your fridge-freezer**

### **Installing:**

- Install the appliance in a cool position. If it is placed in direct sunlight or next to an oven or other heat source, the energy consumption can increase substantially.
- Ensure the appliance is installed with the correct ventilation requirements. Restricting ventilation can increase the energy consumption by 15%.

### **Cleaning and Maintenance:**

- Occasionally clean the condenser coils (if present) at the back of the appliance to maintain a high performance level.
- Clean the door gasket with warm water or a neutral detergent that leaves no residue. A tight-sealing door gasket is critical to the efficiency of your appliance.

### **Usage:**

- Do not open the door repeatedly or more frequently than you have to.
- Do not set the thermostat too low. A change of just one degree can effect the energy consumption by 5%. Use a thermometer to check the temperature.



- The freezer compartment should operate at -15 to -18 degrees Celsius. The refrigerator should operate at around 3 to 4 degrees Celsius.
- Allow food to sufficiently cool before putting it in the appliance (but don't let it sit at room temperature for too long).
- In the freezer compartment, food packages should be scattered and never grouped or stacked together until they are completely frozen.
- If you are going away for a long period of time, turn off the appliance, empty and clean it and leave the door ajar.
- If you have a second appliance that is not used, make sure that it is stored with the power off and the door left ajar until it is actually required.

### Disposing:

- If you're going to throw out your old fridge, see if there's a chlorofluorocarbons (CFCs) recycler in your area. The government department which looks after the environment in your area may be able to help you.

## Cleaning and maintenance

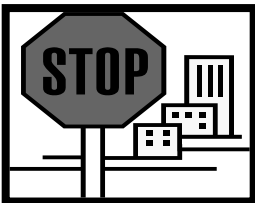

***WARNING: PLEASE ENSURE THAT YOUR APPLIANCE IS DISCONNECTED FROM YOUR MAINS SUPPLY BEFORE ATTEMPTING TO CLEAN IT.***

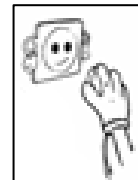

- Do not clean the appliance by pouring water onto it or spraying water over it.



- The refrigerator and freezer sections should be cleaned periodically, using a solution of bicarbonate of soda and lukewarm water.

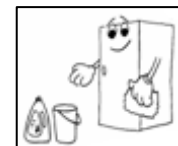

- Clean the accessories separately with soap and water. Do not clean them in a dishwasher.

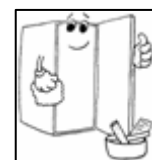

- Do not use abrasive products, detergents or soaps.



- After washing the appliance, wipe over the area that you have cleaned with a damp cloth and then dry it thoroughly.
- When cleaning is complete, dry your hands and then reconnect the plug to your mains supply.

### Replacing the light bulb

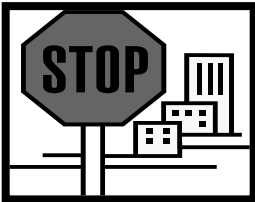

***WARNING: PLEASE ENSURE THAT YOUR APPLIANCE IS DISCONNECTED FROM YOUR MAINS SUPPLY BEFORE ATTEMPTING TO REPLACE THE LIGHT BULB.***

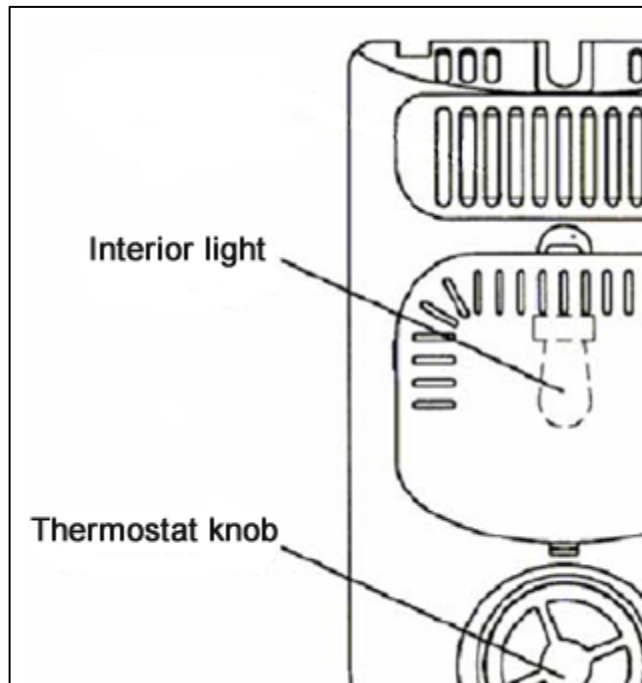

- Remove all adjustable shelves for your safety before changing the light bulb.
- Hold and gently lift up the light bulb cover to allow access to the bulb.
- Remove the old bulb by unscrewing it in an anti-clockwise direction.
- Replace with a new bulb of the same type (15W) by screwing it in a clockwise direction. Take care to ensure that the bulb is fully secured in the bulb holder.

- Refit the light bulb cover and reconnect your appliance to the mains supply and turn on.

### The defrost drain hole

- Defrosting occurs automatically in the refrigerator section during operation. The defrost water is collected by the evaporating tray and evaporates automatically.
- The drain hole should be cleaned periodically with a drain hole cleaner. This will prevent water from collecting in the bottom of the refrigerator, instead of flowing down the defrost drainage channel and drain hole.
- **IMPORTANT:** Please note that the drain hole cleaner should not be left in position permanently. Otherwise this may prevent the defrost water from entering the drain hole.
- You can also pour a small amount of water down the drain hole to clean the defrost drainage channel.
- You should be careful to make sure that food packages do not touch the rear wall of the appliance, as this can interrupt the automatic defrosting process and deflect water into the base of the refrigerator section.
- Use a solution of bicarbonate of soda and lukewarm water to clean the evaporating tray.
- **IMPORTANT:** It is normal to get some ice droplets forming on the back wall of the appliance. The formation of ice droplets does not indicate an appliance fault.

### Defrosting the freezer compartment

Your appliance is frost free, so you should not need to manually defrost the freezer section.

However if for example the door is left open for a prolonged period of time or the door gasket is not sealing correctly, then you could get ice building in the freezer section. If this occurs, then you should follow the steps below.

- Whilst defrosting the appliance, the food should be removed from the compartment and wrapped in several layers of paper and stored in a cool place. The foods rise in temperature will shorten its storage life and therefore the food should be used within a relatively short period of time.

- **DO NOT PLACE FOOD BACK IN THE FREEZER COMPARTMENT THAT HAS STARTED TO THAW.**
- Turn the appliance off by turning off the power supply to the fridge freezer.
- Remove the drawers and shelves from the freezer section and leave the door to the freezer compartment open. You can place a bowl of warm water inside the freezer compartment to speed up the defrost process.
- You can use a sponge to mop up the defrost water that will run into the bottom of the freezer section.
- ***IMPORTANT:*** You should place some old towels on the flooring that is immediately in front of the appliance. In case any defrost water comes out of the freezer section and onto the floor.
- Once all the ice that has built up has melted, then the inside of the freezer compartment should be dried thoroughly. Failure to do this will result in immediate ice build up when the appliance is turned back on.
- With dry hands, reconnect your appliance to your mains supply. You should select thermostat position 5 for a 24 hour period, before returning it to the normal temperature setting of 3.
- You should not attempt to freeze fresh food inside the freezer compartment until this 24 hour time period has elapsed.
- ***Do not defrost the appliance with other electrical devices (e.g. hair dryer). Do not use sharp metal objects to remove the ice on the freezer, as this could cause damage to the refrigerant system.***

## Installation

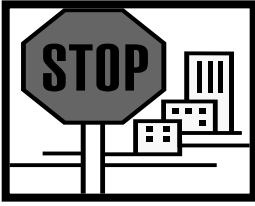

**IMPORTANT: Before installation and usage read all the instructions and make sure that the voltage (V) and the frequency (Hz) indicated on the rating plate are exactly the same as the voltage and frequency in your home. The rating plate can be found on the front left edge of the inside of the fridge section.**

The manufacturer declines all responsibility in the event of the installer failing to observe all the accident prevention regulations in force, which are necessary for normal use and the regular operation of the electric system.

### Electrical connection

**YOUR FRIDGE FREEZER IS INTENDED FOR FITTED AND PERMANENT INSTALLATION.**



We recommend that the appliance is connected by a qualified electrician, who is a member of the N.I.C.E.I.C. and who will comply with the I.E.E. and local regulations.

- Your refrigerator comes supplied with a 13 amp plug fitted. If in future you need to change the fuse in this plug, then a 13 amp ASTA approved (BS 1362) fuse **must** be used.
- The wiring in the mains lead is coloured as follows:

<b>Brown</b>	Live
<b>Blue</b>	Neutral
<b>Green and yellow</b>	Earth

- As the colours of the wires in the appliance's mains lead may not correspond with the coloured markings identifying the terminals in your spur box, please proceed as follows:

The **brown wire** must be connected to the terminal marked "L" (live), or coloured **red**.

The **blue wire** must be connected to the terminal marked "N" (neutral), or coloured **black**.

The **green and yellow wire** must be connected to the terminal marked "E" (earth), or by the earth symbol, or coloured **green and yellow**.

- When the connection is completed, no stray strands or cut wire should be present. The cord clamp must be secured over the outer sheath.

## Reversing the door swing

- You can choose whether you want the doors of your appliance to open from the left or the right according to your kitchen design or personal preference.
  - It is important that this procedure is carried out before the fridge-freezer is positioned in the desired location. ***The appliance should not be connected to the mains supply.***
  - The door reversal process should only be carried out by a suitably qualified person. It is recommended that 2 people handle the fridge-freezer during assembly. All parts that are removed should be saved for reinstallation.
  - The fridge-freezer should be rested on something solid so that it will not slip during the door reversal process. ***Do not lay the fridge-freezer flat as this may damage the coolant system.***
- 1) Carefully tilt the fridge freezer to allow access to the bottom of the freezer door. This requires 2 people to avoid damage or injury.

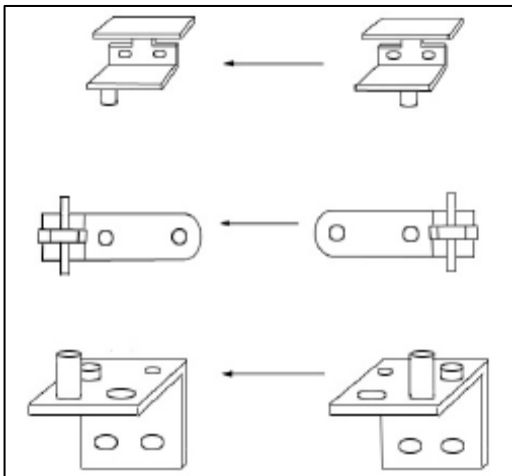

- 2) Unscrew the bolts that hold the lower hinge bracket in place.
- 3) Move the two fittings on the lower hinge bracket to the opposite pair of holes.
- 4) Lay the bracket and bolts to one side for later use.
- 5) Remove the screw and plastic hinge bush and relocate it to the opposite side.
- 6) Remove the freezer door and place on a cushioned surface.
- 7) On the bottom of the fridge door, unscrew the bolts which retain the middle hinge and remove the fridge door. Place it on a cushioned surface.
- 8) Near the top cover, unscrew the upper hinge pin and relocate it to the opposite side.

9) Replace the fridge door and the middle hinge.

10) Replace the freezer door and the lower hinge.

11) Check that the doors are properly aligned and both door seals make contact with the appliance at all points before tightening up all the screws and bolts.

12) Return the fridge freezer to its upright position. If necessary, the hinge positions can be adjusted to ensure the doors are level and efficiently sealed.

## Positioning

- It is advisable that your appliance is only installed in a location where the ambient temperature of the room, corresponds with the climate classification that is stated on the rating plate of your appliance. Your appliance may not function correctly if the ambient temperature falls outside of the following ranges.

<b><i>Climate classification</i></b>	<b><i>Appropriate ambient temperature</i></b>
SN	+10 to +32 degrees centigrade
N	+16 to +32 degrees centigrade
ST	+18 to +38 degrees centigrade
T	+18 to +43 degrees centigrade

- Positioning the appliance requires two people in order to avoid injuries or damage to the appliance.
- Keep a minimum of 100 mm between your refrigerator and the back wall. There should also be a gap of 100 mm either side. If there is insufficient space this can create the sound of vibration, weakening of the refrigerator's power and a waste of electricity.
- The appliance should never be placed upside down or carried in a horizontal position.
- Your appliance should not be located in direct sunlight or exposed to continuous heat or extremes of temperature (e.g. next to a radiator or boiler). If this is not possible, then you should install an insulation plate between the appliance and the adjacent heat source.
- You should check whether there is an electrical socket available, which will be accessible after your appliance is installed.
- Place the appliance flatly and firmly on a solid base. The appliance is fitted with adjustable feet on the front side, which can be used to level the appliance.

- If the front of the appliance is positioned slightly higher than the rear, the door can be opened and closed more easily.

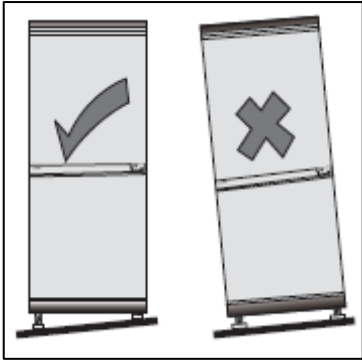

- If your refrigerator tilts down to the left, turn the left adjusting leg until the appliance is level.
- If your refrigerator tilts down to the right, turn the right adjusting leg until the appliance is level.

- Be sure to leave enough space for the opening of the door, to avoid damage to the appliance or personal injury.

## Troubleshooting



***IMPORTANT: If your fridge freezer appears not to be operating properly, before contacting the Baumatic Customer Care Department, please refer to the checklist below.***



***My fridge freezer does not appear to be working/there is no power to my appliance.***

- Check that the plug is fully inserted into the power socket.
- Check that there is power to your mains supply (e.g. that there hasn't been a power cut or that the fuse hasn't blown).
- Check that the control dial has not been turned to the off setting (0).
- Check that your mains supply voltage, corresponds to the voltage stated on the rating plate of your appliance.



***My fridge freezer appears to be performing poorly.***

- Check that the appliance isn't overloaded and that food hasn't been packed too tightly into it.
- The thermostat setting is too low; you should turn the thermostat dial to a higher number.



- Ensure that the doors are closing properly and that the doors have not been opened for a prolonged period in error.
- Ensure that there is adequate ventilation for your appliance.



***My fridge freezer is noisy.***

- The refrigerant gas that circulates the pipework of the appliance may make a slight noise, even if the compressor is not running.
- If the noise worsens or the appliance gets louder than normal; check that it is levelled off correctly, that nothing is touching the rear of the fridge freezer and that nothing placed inside the appliance is rattling.



***Ice has formed on the inner back wall of my fridge.***

- Check that food has not been pushed too far back inside the appliance, so that it is in contact with the inner back wall.
- ***IMPORTANT:*** *It is normal to get some ice droplets forming on the back wall of the appliance. The formation of ice droplets does not indicate an appliance fault.*



***IMPORTANT: If your appliance appears not to be operating correctly, then you should disconnect it from your mains supply and then contact the Customer Care Department on telephone number (0118) 933 6911.***

***DO NOT ATTEMPT TO REPAIR THE APPLIANCE YOURSELF.***

Please note that if an engineer is asked to attend whilst the product is under guarantee and finds that the problem is not the result of an appliance fault, then you may be liable for the cost of the call out charge.

***The appliance must be accessible for the engineer to perform any necessary repair. If your appliance is installed in such a way that an engineer is concerned that damage will be caused to the appliance or your kitchen, then he will not complete a repair.***

***This includes situations where appliances have been tiled in, sealed in with sealant, have wooden obstructions placed in front of the appliance, like plinths. Or any installation other than the one specified by Baumatic Ltd. has been completed.***

Please refer to the conditions of guarantee that appear on the warranty card that you receive with the appliance.

***IMPORTANT: Baumatic Ltd. operates a policy of continuous improvement and reserves the right to adjust and modify its products without prior notification.***

## Baumatic Consumables

- **BC001** Degreaser for Dishwashers (200 g)
- **BC002** Descaler for Washing Machines and Dishwashers (200 g)
- **BC003** Ceramic Hob Cleaner (250 ml)
- **BC004** Oven Cleaner (250 ml)
- **BC005** Stainless Steel Cleaner and Protector (250 ml)
- **BC007** E-Cloth – General Purpose Cloth
- **BC008** Microwave Cover

To order a Baumatic consumable product please call 0123 5437 244 and quote the product code. You can also order online from [eshop.baumatic.co.uk](http://eshop.baumatic.co.uk)

## Technical Data

Manufacturer	BAUMATIC LTD
Model Number	BRCF1960SL/W
Product Category	7 – Refrigerator-Freezer
Energy Efficiency Class <b>(1)</b>	A+
Annual Energy Consumption <b>(2)</b>	266 kWh
Storage Volume of Fridge Compartment	210 litres
Storage Volume of Freezer Compartment	69 litres
Star Rating	4
Frost Free Compartments	Fridge and Freezer
Temperature Rise Time	10 hours
Freezing Capacity	3.5kg/24hr
Climate Class <b>(3)</b>	ST
Noise Level	45 dB
Installation Type	Freestanding

**(1)** On a scale from A+++ (highest efficiency) to G (lowest efficiency).

**(2)** Annual energy consumption based on standard test results for 24 hours. The actual energy consumption will depend on how the appliance is used and where it is located.

**(3)** This appliance is intended to be used at an ambient temperature between "18°C" (lowest temperature) and "38°C" (highest temperature).



***United Kingdom***

Baumatic Ltd.,  
Baumatic Buildings,  
6 Bennet Road,  
Reading, Berkshire  
RG2 0QX  
United Kingdom

**Sales Telephone**

(0118) 933 6900

**Sales Fax**

(0118) 931 0035

**Customer Care Telephone**

(0118) 933 6911

**Customer Care Fax**

(0118) 986 9124

**Spares Telephone**

(01235) 437244

**Advice Line Telephone**

(0118) 933 6933

**E-mail:**

sales@baumatic.co.uk  
customercare@baumatic.co.uk  
spares@baumatic.co.uk  
technical@baumatic.co.uk

**Website:**

[www.baumatic.co.uk](http://www.baumatic.co.uk)

**Facebook:**

[www.facebook.com/baumatic.uk](http://www.facebook.com/baumatic.uk)

***Republic of Ireland***

**Service Telephone**

1-890 812 724

**Spares Telephone**

091 756 771

***Czech Republic***

Baumatic CR s.r.o.  
Lípová 665,  
460 01, Liberec 4  
Czech Republic

+420 483 577 200

[www.baumatic.cz](http://www.baumatic.cz)

***Slovakia***

Baumatic Slovakia, s.r.o.  
Galvániho 7/D  
Slovakia

+421 255 640 618

***Germany***

Baumatic Gmbh  
Bachstr.10-12  
D-32257 Bünde  
Deutschland

+49 (0) 5223 99408 0

[www.baumatic.de](http://www.baumatic.de)

***Italy***

Baumatic Italia S.R.L.  
Via Galvani N.3  
35011 Campodarsego (PD)

+3904 9920 2297

[www.baumatic.it](http://www.baumatic.it)

***Holland***

Baumatic Benelux B.V.  
Dukdalfweg 15d  
1332 BH ALMERE  
Nederland

+31(0)36 549 1553

[www.baumatic.nl](http://www.baumatic.nl)





