

BFWM1406W 60 cm 6 kg

BFWM1407W 60 cm 7 kg

**Freestanding
Washing Machine**

INSTRUCTION MANUAL



Baumatic®

USER MANUAL FOR YOUR BAUMATIC

BFWM1406W 60 cm 6 kg
BFWM1407W 60 cm 7 kg

Freestanding washing machine



NOTE: This User Instruction Manual contains important information, including safety & installation points, which will enable you to get the most out of your appliance. Please keep it in a safe place so that it is easily available for future reference; for you or any person not familiar with the operation of the appliance.

Contents

Environmental note	4
Important safety information	5 – 6
Specifications	7
Description of the appliance	8 - 11
Control panel	9
LED display	10 - 11
Detergent drawer	11
Preparing the wash cycle	12 - 16
Preparing your garments for washing	12
A selection of wash care symbols	13
Detergents and conditioners	13 - 14
Wash program table	15
Wash program guidance	16
Selecting a wash program	16 - 20
Setting a wash program	16
End of cycle	16 - 17
Pausing a wash program	17
Delay start feature	17
Manual soaking	18
Additional wash cycle options	18
-Easy-Iron function	18
-Extra wash	19
-Soak wash	19
-Speed wash	19
-Intense wash	19
Child lock	20
My cycle	20
Power off memory	20
Maintenance and cleaning	21 - 27
In daily use	21
Control panel and washing machine cabinet	21
Detergent drawer	21 - 22
The washing machine drum	22
Door	22
Cleaning the drain pump filter	22 - 23
Cleaning the water inlet filter	24
Winter storage	24
Removing stains	25
Stain removal rules	25
Stain removal guide	25 - 26
Poor wash results	27
Installation	28 - 33
Removing the transit bolts	28
Locating your washing machine	29
Connecting to the mains water supply	30
Connecting to the water outlet	31
Levelling the appliance	32
Power supply	32 - 33
Before first use maintenance wash	33
Error code failure system	33 - 34
General troubleshooting	34 - 36
Baumatic consumables	37
Technical data	38
Contact details	39

Environmental not

This appliance is marked according to the European directive 2002/96/EC on Waste electrical and Electronic Equipment (WEEE). By ensuring this product is disposed of correctly, you will help prevent potential negative consequences for the environment and human health, which could otherwise be caused by inappropriate waste handling of this product.

The symbol  on the product, or on the documents accompanying the product, indicates that this appliance may not be treated as household waste. Instead it shall be handed over to the applicable collection point for the recycling of electrical and electronic equipment.

Disposal must be carried out in accordance with local environmental regulations for waste disposal.

For more detailed information about treatment, recovery and recycling of this product, please contact your local city office, your household waste disposal service or the shop where you purchased the product.



Important safety information



Your safety is of the utmost importance to Baumatic. Please make sure that you read this instruction booklet before attempting to install or use the appliance. If you are unsure of any of the information contained in this booklet, please contact the Baumatic Advice Line.

General Safety

- Repairs to your appliance must only be carried out by a Baumatic engineer or one of its authorised service agents. Any attempt by an inexperienced person to repair the appliance, could result in injury or damage to your washing machine.
- If you notice that the mains cable is damaged. ***The appliance must not be used.*** The same applies if you notice that the worktop, control panel or base area is damaged. As this could allow access to the internal components of the machine.
- The appliance should be turned off and isolated from the mains supply, before either cleaning or maintenance work is attempted.
- The mains cable must not be used to pull the plug out of the electrical socket.
- The machine should not be sprayed with water.
- The glass of the porthole door may become hot during the higher temperature wash programs.
- The machine should be allowed to cool before carrying out an emergency drain or cleaning the drain filter.
- It is possible for small animals to chew either the mains cable or water hoses, which could cause an electric shock hazard.

Installation

- The installation instructions contained within this user manual should be followed.
- It is obligatory for the completed installation to comply with all relevant building regulations and local water authority requirements.

- ***Before the first use of the appliance, we advise that a 95 degree cotton wash is completed. No garments should be placed inside the machine; however a small amount of detergent must be used.***

During Use

- It is recommended that the appliance is unplugged and the water supply is turned off after the machine is used.
- This appliance is only designed to wash normal domestic wash loads. If you use your washing machine in any other way or it is incorrectly used, then Baumatic accepts no liability for any damage that might be caused and any guarantee will be void.
- No attempt should be made to alter or modify the specifications of this appliance.
- The detergents that you place in this appliance should be suitable for automatic washing machines. With regards to dosage levels, the detergent manufacturer's recommendations should be followed.
- You should not wash garments that have been in contact with flammable materials.
- Your washing machine should not be used for dry cleaning.
- If you use either dyes or bleaching agents inside this machine, then you should consult with the manufacturer of these products to make sure they are suitable for use in your washing machine. Baumatic cannot be held responsible for any damage that may result.

Child Safety

- Your washing machine should only be used by adults. You should not allow children in the area of the machine unsupervised. You should not let them touch the controls or play with the appliance.
- It could be possible for a child or pet to gain access to the washing machine through the porthole door. Therefore please check the drum before using the appliance.
- Any packaging that is removed from the machine should be kept away from children.
- All detergents should be kept out of a child's reach and in a safe place.

Specifications

- 12 wash programs
- 6 kg wash load (BFWM1406W)
- 7 kg wash load (BFWM1407W)
- 1400 rpm maximum spin speed

- LED display
- Electronic control operation
- Spin speed regulation
- Separate temperature regulation
- Delay start
- Digital countdown indicator
- Wash phase indicator
- Door locked indicator
- 180° door opening
- Failure detection system
- Imbalance control system
- Overflow protection
- Foam protection
- Anti-crease function
- Stainless steel drum
- Removable top for built-under installation
- Adjustable feet
- Child lock

Appliance dimensions

Height: 855 mm
Width: 595 mm
Depth: 520 mm (BFWM1406W) / 575 mm (BFWM1407W)

Ratings

Energy efficiency class (wash only)	A++
Wash performance class	A
Water extraction performance class	C

For future reference please record the following information which can be found on the rating plate and the date of purchase which can be found on your sales invoice. The rating plate for your washing machine will either be located on the right hand side of the cabinet or behind the porthole door.

Model Number

Serial Number

Date of Purchase

Description of the appliance

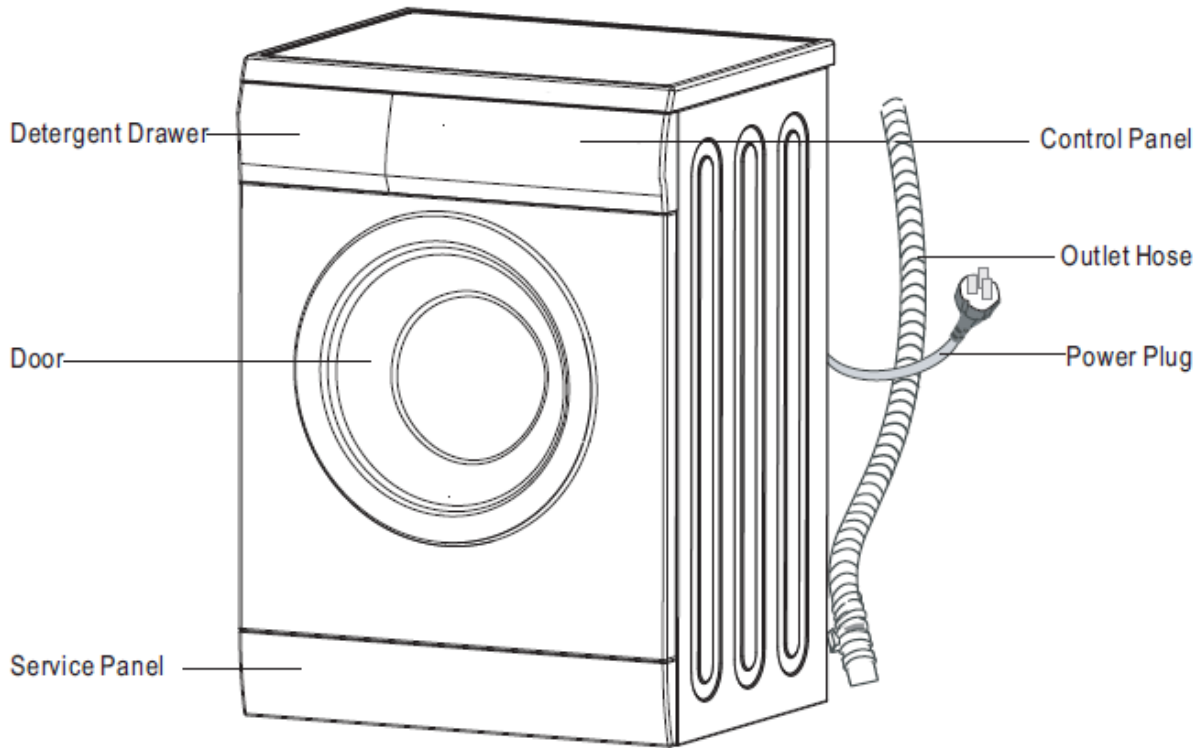

Accessories

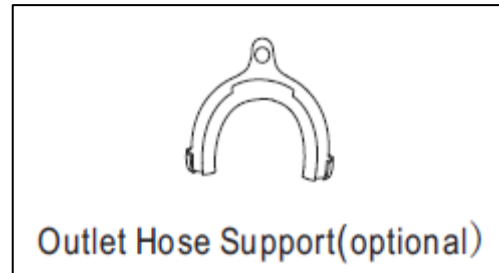
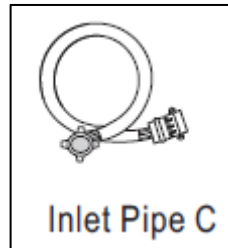
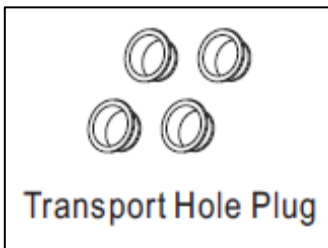

Control panel

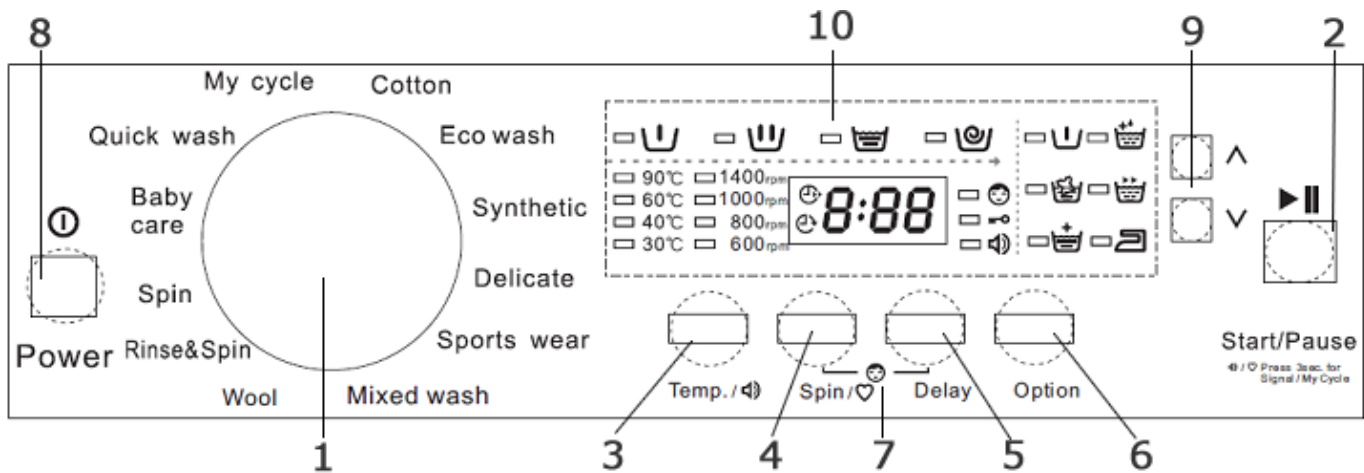

- 1) **Washing program selection dial.** Use this dial to select the required washing program.
- 2) **Start / pause button.** Press this button to start or pause a washing cycle.
- 3) **Temperature selection button.** Press this button to set the temperature of the water for a washing program from the following options: **Cold → 30°C → 40°C → 60°C → 90°C**
- 4) **Spin speed selection button.** Press this button to select the spin speed for the chosen washing program from the following options: **No Spin → 600 → 800 → 1000 → 1400**
- 5) **Delay start button.** Press this button to delay the start of the washing cycle. Repeatedly press the button to choose a time between 0-24 hours.
- 6) **Option button.** Press this button to select additional functions for your washing cycle.



- 7) **Child lock.** Press the Spin button (4) and the delay button (5) simultaneously for 4 seconds to lock all the other keys on the control panel to prevent accidental operation by unauthorised persons such as children.
- 8) **Power button.** Press this button to turn the appliance on/off.
- 9) **Selection buttons.** Use these buttons to scroll through the additional wash cycles options.

LED display

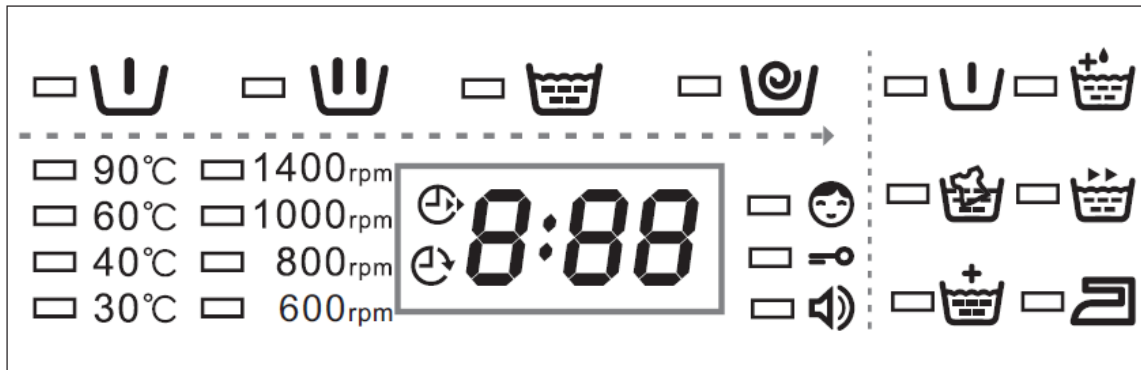



Wash cycle progress indicators. The current wash cycle phase will light on the control panel to indicate the progress of the program from "Pre-Wash", "Wash", "Rinse" and "Spin".



Extra/optional wash cycle indicators. Displays the selected optional wash cycle options such as "speed wash" and "soak wash". This is also the method of choosing to add a "prewash" cycle.



 **Delay start indicator.** The remaining time of the wash delay will be displayed until the countdown time ends and the wash program begins.

 **Remain indicator.** After the washing cycle has begun, the remaining time of the wash cycle will be displayed until the wash program ends.

 **Child locked.** When the child-lock function is activated this icon will light. The light will go off when the lock is deactivated.

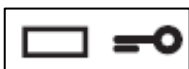
 **Door locked.** This LED will light to show that the door is locked. When the light is out it means that the door is unlocked.

 **Audible signal indicator.** This LED will light to show that the audible alarm is operational. You can deactivate the audible alarm.

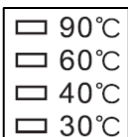

Temperature display. The LED's will show what temperature has been set.

- 1400_{rpm}
- 1000_{rpm}
- 800_{rpm}
- 600_{rpm}

Spin speed display. The LED's will show what spin speed has been set.



Audible signal adjustment button. Press and hold the Temp button for 3 seconds to turn the audible signal on/off.



"MY cycle" adjustment button. Press and hold the Spin button for 3 seconds to save your personalised wash cycle.

Detergent drawer

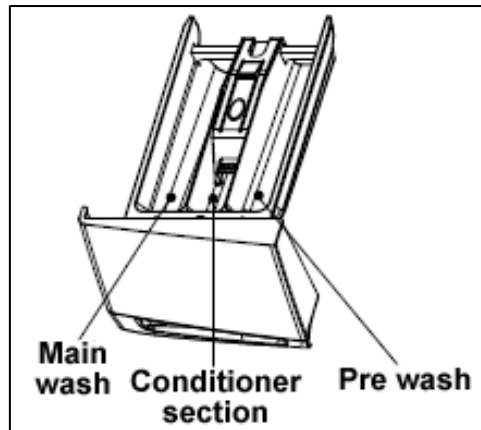

Main wash section

This compartment should have detergent placed in it (you should also put a water softening agent in this section, if you use one). The detergent will be added to the drum at the start of the main wash program.

Conditioner section

This compartment should be used for liquid conditioners (fabric softener, starch). They will be added to the wash load during the final rinse.

Pre wash section

This compartment should have detergent placed in it, if you are going to select a pre-wash before the main wash cycle.

Preparing the wash cycle

Preparing your garments for washing

- Your washing should be sorted out, according to the fabric type and the wash care symbol that is printed on the garment's wash care label (see separate section on wash care symbols).

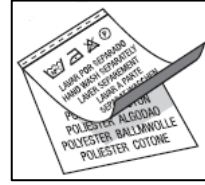

- Your washing should also be sorted out according to the degree of soiling.
- Check all pockets on a garment to make sure that they are empty.

- Remove any detachable metal items (badges, paperclips, safety pins etc).

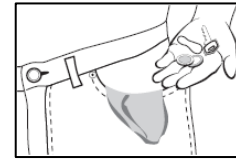

- Zips should be closed, duvet covers and pillow cases should be buttoned up and any loose straps should be tied up. This will help to prevent other garments from getting damaged during the wash.

- Woollens and knitted coloured fabrics should be turned inside out before being washed in the appliance.

- Small delicate items (tights, baby socks) should be placed in either a washing net or a zipped pillow case.

- Curtains should be handled with particular care. All plastic hooks or metal strips must be removed before being washed in the appliance.

























- Coloured items and whites should be washed in separate wash cycles.



- New garments often contain an excess of dye, therefore it is advisable to wash them separately for their first wash.

- Garments should be unfolded and shook out before being placed inside the machine.

A selection of wash care symbols

Washing	 Boiling temp 95°C	 Normal temp 60°C	 Normal temp 40°C	 Do not wash!	 Bleachable in cold water	 Do not bleach!	 Wool seal
Dry cleaning	 Delicate temp 30°C	 Delicate temp 40°C	 Hand wash only	 All solvents	 All but TRI	 Benzine only	 Do not clean!
Spin dryer	 Normal	 Low	 High	 Do not dry!	 Hang to dry	 Drip dry	 Dry flat
Ironing	 110°C	 150°C	 200°C	 Do not iron!			

- The wash care symbols should be used to help you to select the most suitable wash program. They will also help you to sort your laundry into different loads, depending on the fabric type and the highest temperature which the garment can be washed at.

Detergents and conditioners

IMPORTANT: Only detergents suitable for use in washing machines should be used.

The amount of detergent that you need to use in your appliance, will depend on

- **The degree of soiling.** Lightly soiled garments in general require less detergent.
- **The size of the wash load.** A smaller wash load will require a reduction in the amount of detergent.
- **The hardness of your tap water.** The harder your water is, then the more detergent you will need to use. The detergent manufacturers normally give guidance as to how much extra detergent should be used, depending on the hardness of the water.

Liquid detergent

If you are using liquid detergent, then in the majority of cases the liquid should be placed inside the dosing device supplied by the detergent manufacturer and placed inside the drum. All instructions on the detergent packaging should be followed.

Low temperatures

- The enzymes in biological washing detergents work best at low temperatures to provide excellent cleaning and stain removal results, but not as low as 20°C.
- Liquid or gel detergents are particularly suitable for low temperature washing as they dissolve easier and quicker than powders or tablets.



Water softening agents

If your tap water is hard, then it may be prudent to utilise a water softening agent. This will help to ensure that the appliance does not become clogged with hard water deposits. You may also find that it will allow you to lessen the amount of detergent that you are using.



When using any detergent or water softening agent, the recommendations of the manufacturers should be followed.

Wash program table

Wash Cycle	Load(kg)		Detergent Box			Prewash	Intensive	Soak	Speed wash	Extra rinse	Less iron	Default Temp. (°C) **	Default Time (Min)	Default Speed (RPM)			
	6.0	7.0												6kg/7kg	800	1000	1200
Cotton *	6.0	7.0	○	●	○	OK	OK	OK	OK	OK	OK	60	3:27 / 3:10	800	1000	1200	1400
Eco wash	1.5	2.0	×	●	○	NO	NO	NO	NO	OK	NO	30	1:08	600	800	1000	1000
Synthetic	3.0	3.5	○	●	○	OK	OK	OK	OK	OK	OK	40	1:12	600	600	800	800
Delicate	1.5	2.5	×	●	○	NO	NO	NO	NO	OK	OK	Cold	1:00	400	600	600	600
Sport wear	3.0	3.5	○	●	○	OK	OK	OK	OK	OK	OK	40	1:25	600	800	1000	1000
Mixed wash	6.0	7.0	○	●	○	OK	OK	OK	OK	OK	OK	40	1:17	600	800	1000	1000
Wool	1.5	2.5	×	●	○	NO	NO	NO	NO	NO	NO	30	0:58	400	600	600	600
Rinse&Spin	6.0	7.0	×	×	○	NO	NO	NO	NO	OK	OK	—	0:32	600	800	1000	1000
Spin	6.0	7.0	×	×	×	NO	NO	NO	NO	NO	NO	—	0:14	600	800	1000	1000
Baby care	6.0	7.0	○	●	○	OK	OK	OK	OK	OK	OK	60	1:46	600	800	1000	1000
Quick wash	1.5	2.0	×	●	○	NO	NO	NO	NO	OK	OK	Cold	0:15	800	800	800	800

* Energy test program Cotton 60°C/40°C. These programs are suitable for cleaning normally soiled cotton laundry and are the most efficient programs.

** The actual water temperature may differ from the declared cycle temperature.

● = Should be used

○ = Optional

×

= Not required

- Detergent and softener only need to be added when required.
- The operation time of the appliance may change according to the water temperature, water level, amount of clothes, inlet water pressure and drain state.

Wash program guidance

- A wash program option can only be selected if the program table advises that it is possible with the wash cycle you have selected.
- **Important:** *You should make sure that the selected spin speed is appropriate for the garments that you are washing.*
- **Important:** *Before opening the door of the appliance, you MUST spin the clothes and drain the water.*
- The active phases will appear in the LED display, as the wash program progresses.
- The LED display shows an approximate time for the selected wash cycle. Please note that factors external to the machine, e.g. the temperature of your water supply, your water pressure etc., can affect the time it takes for a wash cycle to complete.

Selecting a wash program

Setting a wash program

- Use the washing program selection dial **(1)** to select the required program.
- You can set the temperature **(3)** and spin speed **(4)** by pressing the relevant buttons on the control panel.
- If you wish to select additional wash cycle options, please refer to the "Additional wash cycle options" section.
- Once the desired wash program and any additional wash cycle options have been selected, press the start / pause button **(2)** to begin the wash cycle.

End of cycle

- When the wash cycle ends an audible signal will sound.
- **IMPORTANT:** *You should not attempt to open the porthole door until the door lock light has gone out.*
- When the door lock light has gone out and you hear the door lock disengage, you can open the porthole door and remove the laundry.

- Turn off the water tap and turn the appliance off by using the on/off button **(8)**.
- Disconnect the appliance from the electricity supply.

Pausing a wash program

- If you want to pause a wash program temporarily, you should press the start/pause button **(2)**.
- When you want to restart the wash cycle, press the start/pause **(2)** button again.

Delay start feature

Your appliance has a delay start feature, which allows you to delay the start of a wash cycle until a later time.



- When the delay start function is in use, the LED display only shows the delay start time and the delay start indicator will light. When the programmed time is reached, the delay start indicator light will go off. The LED display will then show the remaining time of the wash cycle and the time remaining indicator will be light.
 - The delay start time on the display informs you in how many hours the wash program will begin.
- 1)** Select a wash cycle and any additional wash cycle options, as described previously.
 - 2)** Press the delay start button **(6)** repeatedly to set the length of time which you wish to pass before the washing cycle begins.
 - 3)** Press the start / pause button **(2)** and the machine will enter standby mode. The cycle will automatically begin when the delay start time is reached.
 - 4)** If you wish to cancel or change the delay start time you will need to scroll through the time until you reach "0" or your desired delay time.

Manual soaking

- 1) Load the laundry into the washing machine drum and put the detergent into the drawer according to the manufacturer's instructions.
- 2) Use the program selection dial **(1)** to select the required wash cycle. Press the start / pause button **(2)** to begin the cycle.
- 3) After approximately 10 minutes have passed, press the start / pause button **(2)** again to pause the cycle. The clothes are then able to soak in the water for your chosen length of time. Press the start / pause button **(2)** to continue the wash cycle.

Additional wash cycle options

- After you have selected your main wash cycle using the selection dial **(1)** you can proceed to select additional wash cycle options by pressing the options button **(6)**.
- After pressing the option button **(6)** you can use the selection buttons **(8)** to highlight your desired optional extras.
- Press the option button again when the desired extra wash cycle is illuminated to set that wash program. This process can be repeated to select multiple optional wash cycle extras.
- Once the desired wash program and any additional wash cycle options have been selected, press the start / pause button **(2)** to begin the wash cycle.

Easy-Iron function

- The Easy-Iron function means that the machine will not execute the last drain of the wash cycle – until the start/pause button is pressed.
- This means that the laundry will sit in the water until you are ready to remove it for drying, preventing it from developing creases.
- This must be selected before starting the wash cycle.

NOTE: The maximum running time of this function is 10 hours. After this time the machine will drain and spin automatically.

Extra rinse

- The extra rinse option is mainly used for the clothes of people with sensitive skin. The laundry will undergo an additional rinse to remove more residues of detergent.
- This must be selected before starting the wash cycle.

Soak wash

- The soak wash option is mainly used for stained clothes. The laundry will undergo a thorough rinse before the main wash cycle.
- This must be selected before starting the wash cycle.
- After the drum fills with water the clothes will be soaked for 5 minutes before the drum rotates for 30 seconds. This process will repeat four times, giving a total of 20/22 minutes of soaking prior to the main wash.

Speed wash

- The speed wash option will decrease the wash times of any cycle, except for the *quick wash* and *spin* cycles, by approximately 20 minutes.
- This must be selected before starting the wash cycle.

Intensive

- The intensive option is mainly used for heavily soiled clothes. The wash time will be extended.
- This must be selected before starting the wash cycle.

NOTE: This function does not work with the following wash programs: *Quick wash, rinse, wool, eco, delicate* and *spin*.

Child lock



Your appliance has a child lock option. If this is set it will mean that nobody can affect the operation of the wash program once it has started.

- When the appliance is in use, press and hold the child lock buttons (Temp **(3)** and Spin **(4)**) for 3-5 seconds to activate the child lock. No buttons on the control panel will be operable. The Child lock symbol / LED will light on the display.
- To deactivate the child lock, press the child lock button again. The Child lock LED will go out and the buttons on the control panel will then be operable again.



My cycle

Your appliance has an option which allows you to set a personalised wash cycle.

- Use the selection dial to select your desired wash program, and then select any additional functions that you want, including selecting your desired temperature and spin speed.

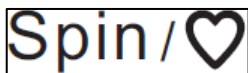

○ Once you are happy with the selection you should press and hold the "Spin" speed button for 4 seconds.

- Now when you turn the selection dial to the "My cycle" it will select all of the functions that you have previously set and stored.
- Your "My cycle" can be modified at any time by repeating the above process.

Power off memory

- You do not need to do anything if the power supply to the machine is cut off in the middle of a cycle.
- The appliance will continue the wash when the power is turned on again.

IMPORTANT: Please do not open the door by force when the power is off.

Maintenance and cleaning

In daily use

- Once a wash cycle has completed, you should pull out the detergent drawer slightly, so it can dry out.
- Leave the porthole door ajar for a short while after a wash cycle has completed. This should help to prevent stagnant smells and to protect the door seal.
- After each washing program has finished, wipe up the remaining water on the rubber seal ring and seal fold to prevent any mildew and rot.
- Close the water tap.
- We suggest that you disconnect the appliance from your mains supply, when it is not in use.

Control panel and washing machine cabinet.

IMPORTANT: Do not use any abrasive cleaner or household polish on either the control panel or operating parts.

- Wipe over the control panel and the external surface of the machine using a brand new damp cloth with warm water.
- If you ever spill any liquid detergent or conditioner from the detergent drawer onto the washing machine cabinet, then these should be cleaned up immediately as they could be corrosive.

Detergent drawer

Occasionally the detergent drawer should be cleaned, to remove any detergent residue that has built up.

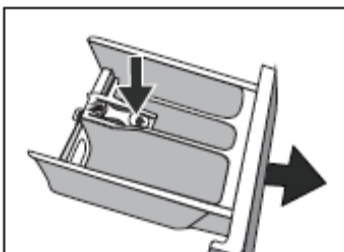

- Press the detergent drawer limit part and pull out the drawer at the same time to remove from the machine.

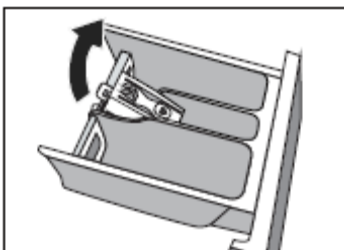

- Remove the central conditioner hole plastic cover by unclipping it at the back.
- Clean the whole drawer thoroughly.

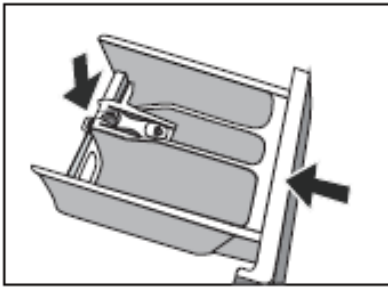

- Detergent can also accumulate inside the detergent drawer recess, so you should also clean this out using warm soapy water and a soft cloth.
- Once you have finished cleaning the detergent drawer and recess, you should re-attach the conditioner cover and slide the drawer back into its original position.

The washing machine drum

The drum of your washing machine is constructed from stainless steel. However if there are objects that can rust placed inside the drum, then it is possible for the drum to become stained.

IMPORTANT: Do not use a descaling agent, iron/steel wool or scouring agents to clean the drum of your appliance.

- Remove any rust stains on the drum with an appropriate stainless steel cleaning agent.

Door

- You should regularly check to see if any deposits have formed, or there are any foreign bodies inside or underneath the rubber door gasket. This sits inside the opening of the porthole door.

Cleaning the drain pump filter

IMPORTANT: Switch off your washing machine and disconnect the plug from your mains supply.

You should clean out the filter approximately every ten washes. If the drain pump filter is not cleaned regularly, then your appliance may find it difficult to pump out water efficiently.



- 1) Open the service panel and place a container close to collect any water spillage.



2) When no more water drains out, unscrew the pump cover and remove it. Always keep a cloth nearby to dry up any water spillage when removing the cover. Remove any objects from the pump impeller by rotating it.



3) Screw the pump cover fully back on.



4) Close the service panel.

IMPORTANT: Never remove the pump cover during a wash cycle. Always wait until the appliance has finished a wash cycle and is empty. When replacing the cover, ensure it is fully tightened to prevent leaks and to prevent children being able to remove it.

IMPORTANT: If you are draining water from the bail hose and drain pump filter in an emergency. You should take care as the water coming from the machine mid-cycle could be hot. Especially if the water is being drained in the middle of one of the hotter wash cycles.

Cleaning the water inlet filter

- Clean the filter approximately every 6 months, when water leaks from the water inlet, or if there are frequent interruptions to your water supply.
- ***Always pull the power plug out before cleaning.***



1) Unscrew the inlet water pipe.

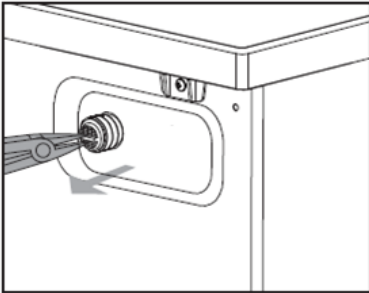

1) Use long-nose pliers to remove the water inlet filter

2) Clean carefully with a gauze brush and then replace.

Winter storage

- You should install your appliance in a location where it will not be subjected to freezing temperatures.
- If you are going to store your appliance in a location where the temperature will drop below freezing in winter, then you should follow the table below.

<i>To winterize the washer</i>	<i>To use the washer again</i>
<ul style="list-style-type: none">• Turn off the water supply.• Disconnect and drain the water inlet hoses.• Run the washer on a drain and spin setting for one minute.• Unplug the power supply cord.	<ul style="list-style-type: none">• Flush the water pipes and hoses.• Reconnect the water inlet hoses.• Turn on the water supply.• Reconnect the power supply cord.

Removing stains





Garments that are covered in stains, grease or are heavily soiled may need to be pre-washed or soaked before being placed inside of the washing machine.









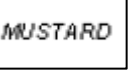

- Soaking helps to remove protein-type stains, like blood, milk or grass.
- Pre-washing helps to loosen soil before the main wash.

Stain removal rules

- Use warm water for soaking or pre-washing stained laundry. Hot water can set stains.
- Most stains are easier to remove when they are fresh.
- Before treating any stain try to establish; what kind of stain it is, how old the stain is, what the fabric type is and whether the fabric is colourfast (check the care label to find this out).
- Washing and drying can fix some stains.
- When bleach is recommended, use a mild fabric bleach that is safe for the fabric.
- If you need to use a stain remover, put the stained area face down on a paper towel or white cloth. Apply the stain remover to the back of the stain. This forces the stain off the fabric, instead of through it.

Stain removal guide

	<i>Stain</i>	<i>Removal Method</i>
	Alcoholic beverages	The stain should be first washed with cold water, then wiped with glycerine and water and rinsed with water mixed with vinegar.
	Shoe polish	The stain should be softly scratched without ruining the material, then rubbed with detergent and rinsed. In case it is not eliminated, rub with 1 unit of pure alcohol (96 degrees) mixed in 2 units of water and then washed with lukewarm water.
	Tea and coffee	Stretch the stained area of material on the top of a container and pour water as hot as the material can endure on it. If the type of material is suitable, wash it with lye.
	Chocolate and cocoa	Leave your clothes in cold water and rub with soap or detergent, wash it in the highest temperature that the material type can endure. If there is still a stain of oil left, wipe with oxygenated water (in proportion of 3%).

	Tomato paste	Scrape the dried pieces without ruining the material, then leave in cold water for about 30 minutes and wash by rubbing with detergent.
	Meat broth/egg	Eliminate the dried stain residues and wipe with a sponge or soft cloth wetted in cold water. Rub with detergent and wash with diluted lye.
	Grease and oil stains	First wipe the residues. Rub the stain with detergent and then wash with lukewarm soapy water.
	Mustard	First apply glycerine to the stained area. Rub with detergent and then wash. If the stain still does not disappear, wipe with alcohol (on synthetic and coloured cloth, a mixture of 1 unit alcohol, 2 units water should be used).
	Blood stain	Lay your clothes in cold water for 30 minutes. If the stain still does not disappear, lay in mixture of water and ammonia (3 table-spoons of ammonia in 4 litres of water) for 30 minutes.
	Cream, ice-cream and milk	Lay your clothes in cold water and rub the stained area with detergent. If the stain has still not disappeared, apply lye on the fabric of your clothes in proper proportion. (Do not use lye on coloured clothes).
	Mould	Mould stains should be cleaned as soon as possible. The stain should be washed with detergent, and if it does not disappear, it should be wiped with oxygenated water (in proportion of 3%).
	Ink	Hold the stained area under cold water and wait until the inky water completely runs off. Then rub with water diluted with lemon juice and detergent. Wait five minutes and then wash.
	Fruit	Stretch the stained area of your clothes on the top part of a container and pour cold water on it. Do not pour hot water on the stain. Wipe with cold water and apply glycerine. Wait for 1-2 hours and rinse after wiping with a few drops of white vinegar.
	Grass stain	Rub the stained part with detergent. If the type of fabric is suitable for use of lye, wash it with lye. Rub your woolen clothes with alcohol (for coloured one, a mixture of 1 unit pure alcohol and 2 units of water).
	Oil paint	The stain should be eliminated before it dries by applying thinner on it. Then it should be rubbed with detergent and washed.
	Burnt stain	If your fabric is suitable for use of lye, you can add lye into your washing water. For woolen fabric, a cloth dampened in oxygenated water should be pressed on the stain and it should be ironed with a dry cloth on it. It should be washed after rinsing well.

Poor wash results

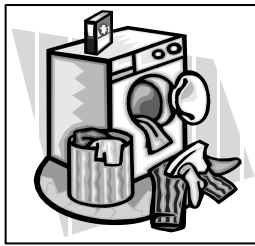

My garments are looking grey and there are limescale deposits present in the drum of my washing machine.

- There is not enough detergent being added.
- The incorrect detergent is being used.
- Stains are not being pre-treated.
- The correct wash program or wash temperature was not selected.



I have followed the advice given above, but my garments are still coming out with grey stains on them.

- The garments are soiled with oils, ointments or grease and were washed without enough detergent.
- The wash temperature selected was too low.
- Fabric conditioner has come into contact with the garments. If this happens try to wash out these stains as quickly as you can and try to avoid getting conditioner on the garments in future.



After the final rinse, I can still see foam.

- Modern detergents can result in there still being foam in the final rinse, this does not mean that the washing is not being rinsed properly.



There is white residue on my garments when I remove them from the appliance.

- Modern detergents can contain insoluble contents; white residue after a wash cycle is not necessarily a sign of the garments being insufficiently rinsed by the washing machine.
- You should shake out the garment or brush it off. In future possibly turn the garment inside out before it is washed. You may wish to move from a powder detergent and switch to a liquid detergent instead.

Installation



IMPORTANT: THIS INSTALLATION MUST BE COMPLETED BY A SUITABLY QUALIFIED PERSON. BAUMATIC ONLY SANCTION THE INSTALLATION GIVEN IN THIS INSTRUCTION MANUAL. YOU SHOULD KEEP THE TRANSIT PACKAGING, IN CASE YOU NEED TO TRANSPORT THE MACHINE IN THE FUTURE.

Removing the transit bolts

IMPORTANT: Before installing or operating the washing machine, **YOU MUST** remove the transit bolts that hold the drum in position whilst the appliance is being transported.

- Keep the transit bolts in a safe location for further use during transportation. Please use a spanner for this procedure.

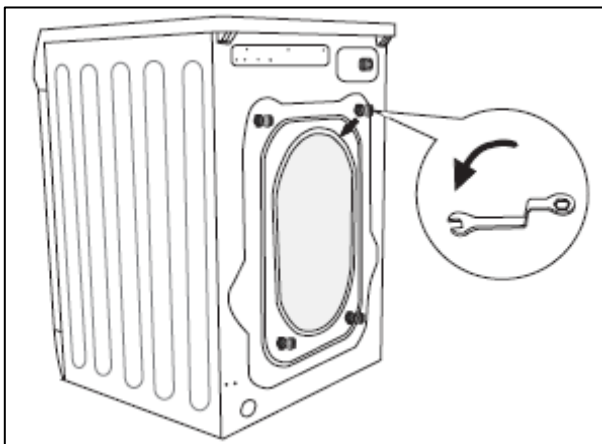

1) Remove the four fixed bolts on the rear of the appliance using a suitable spanner.

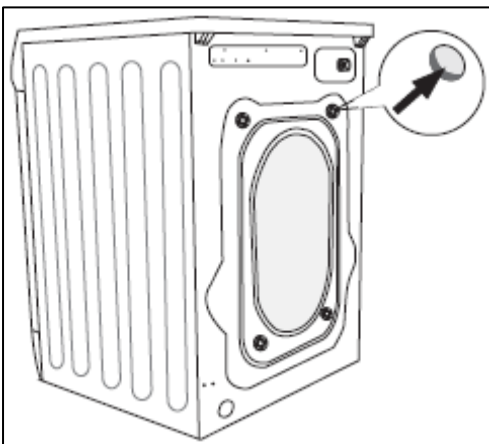

2) Insert the hole covers into the holes to close them.

Locating your washing machine

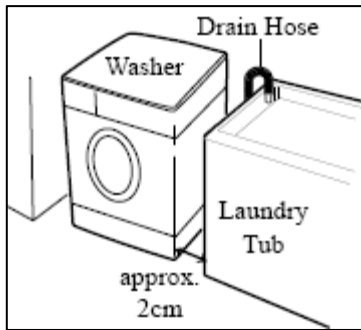

- Before commencing installation, check the location where you intend to install the appliance. You should make sure that you have everything in place that is necessary for the correct installation.
- Do not place or store your washing machine in a location where the ambient temperature could fall below 0°C, otherwise the water in it could freeze up.
- Never place or store laundry products on top of the appliance.
- Install the washer on a flat, solid floor. If the washer is installed on an uneven or suspended floor, it could cause excessive noise and severe vibration, which may result in the malfunction of the appliance.
- You should also level off the washing machine, using the adjustable feet on the base of the appliance.
- There should be a gap of 2 cm either side of the washing machine; a 10 cm gap should be left behind the appliance.

Connecting to the mains water supply

IMPORTANT: The washing machine should never be connected to the water mains using an existing inlet hose, **YOU MUST** utilise the inlet hose that is provided with the appliance.

Your appliance should only be connected to a cold water supply.

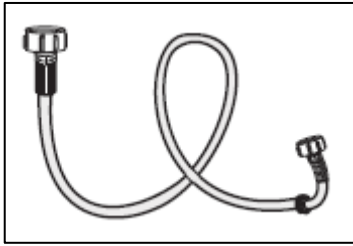

1) Take out the attached inlet hose.

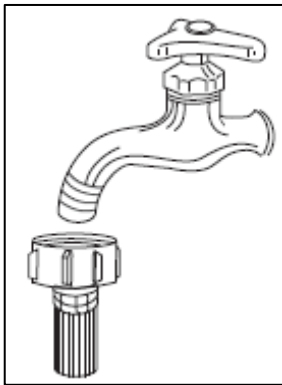

2) Attach the inlet hose vertically to the spiral tap for the washing machine.

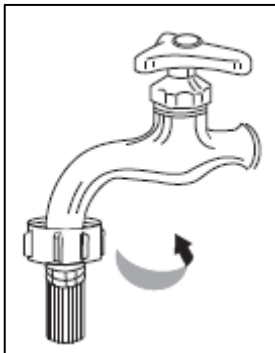

3) Screw the tap tightly in the direction of the screw thread of the inlet hose.

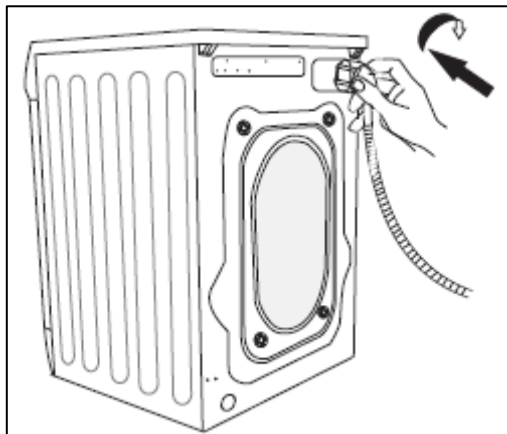

4) Connect the hose to the water inlet at the back of the washing machine.

IMPORTANT: When connecting the screw thread of the inlet hose and the inlet valve, prevent the screw thread from being secured incorrectly or it will wear or leak.

Do not over bend the inlet hose or this will cause damage.

Connecting to the water outlet

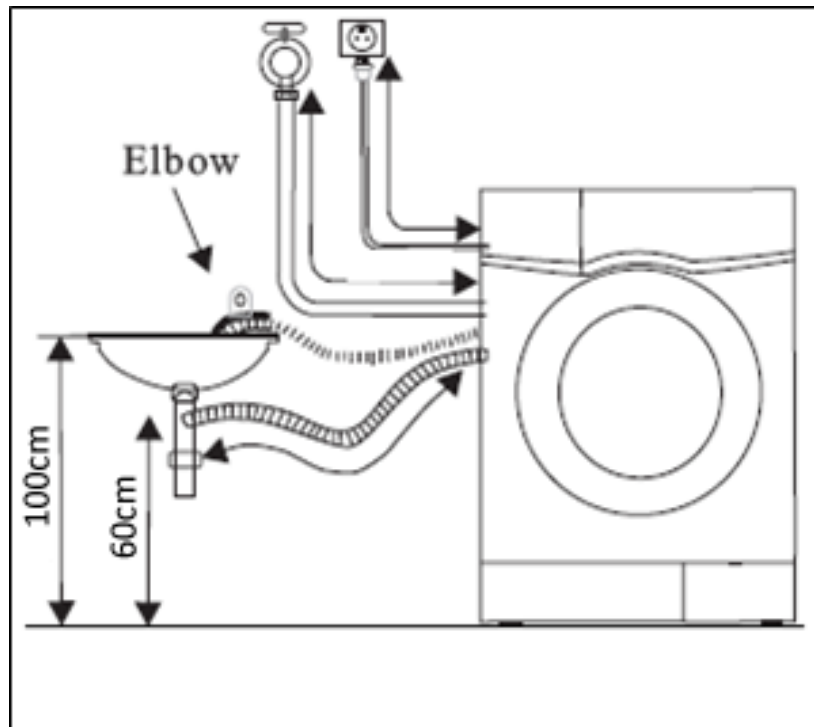

- 1) Please use an elbow to bend the drain hose at a proper angle and fix securely.

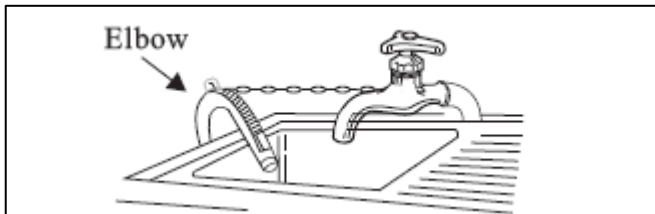

- 2) The correct position of the drain hose is one which will prevent any water leaking onto the floor or other surfaces.

IMPORTANT: Do not insert the drain hose too deeply into the water pipe, as this may cause siphoning.

- 3) To prevent siphoning, the installation height of the drain hose should be between 0.6 – 1 m and the end of the drain hose should not be immersed in water.

NEVER EXTEND THE DRAINAGE HOSE FROM ITS ORIGINAL LENGTH.

Levelling the appliance

- Place the washing machine on a solid and level floor surface.

DO NOT PLACE THE WASHING MACHINE ON A CARPET OR A SUSPENDED FLOOR.

- If the floor is obviously uneven, the appliance needs to be adjusted to prevent the drum from inclining or the machine from moving while in use. Use the adjustable feet to level the appliance.

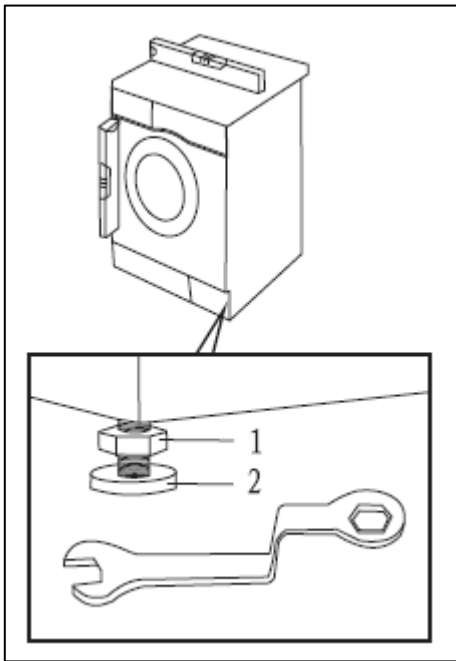

- 1) Unscrew the adjusting nut (1) with a spanner.
- 2) Adjust the height of the legs using the foot (2).
- 3) Screw the nut (1) to secure the levelling foot.

IMPORTANT: There should be no instability of the machine when the adjustable legs have been set to the correct level.

Power supply

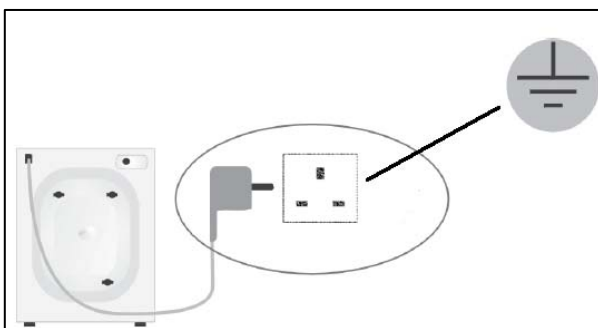

- ✓ **IMPORTANT:** The electrical socket must still be accessible once the appliance is installed.

- ✓ Consult the rating plate **BEFORE** making the electrical connections. Ensure that the voltage reaching the plug, is the same as that on the rating plate.
- ✓ **DO NOT REMOVE THE RATING PLATE AS THE INFORMATION ON IT IS IMPORTANT.**

- ✓ The moulded plug that is supplied with the appliance must be placed into an earthed and insulated socket.
- ✓ Broken or damaged power leads must only be replaced by a suitably qualified person. A power lead of a similar type must be used in replacement.
- ✓ **IMPORTANT:** *We do not recommend that this appliance is connected to an extension lead.*

Before first use maintenance wash

- When your washing machine has been correctly installed, we recommend that you perform a high temperature wash cycle, without any clothing being placed inside of the drum.
- This will check that all aspects of the installation are correct; it will also remove any deposits that may have been left on the drum by the manufacturing process.

Error code failure system

If your appliance senses that it is not operating correctly, then an error code may appear on the LED display.

The following error codes can possibly be remedied by the customer and the steps outlined below should be followed.

BEFORE COMPLETING ANY MAINTAINANCE ON THE APPLIANCE, IT SHOULD BE DISCONNECTED FROM YOUR POWER SUPPLY.

<i>Error code</i>	<i>Reason</i>	<i>Solutions</i>
E10	Inlet water overtime.	<ul style="list-style-type: none"> ○ Open the water tap to check if the inlet hose is squashed or kinked. ○ Check if the filter in the inlet valve is blocked or not. ○ Check if the water pressure is too low.
E21	Overtime of the drainage.	<ul style="list-style-type: none"> ○ Check if the drain pump is blocked (see relevant section).
E30	The door has not been closed.	<ul style="list-style-type: none"> ○ Check if the door of the washing machine is closed. ○ Check if the clothes are preventing the door from closing properly.
EXX	Other	<ul style="list-style-type: none"> ○ Contact the Customer Care Department.



If a fault code reappears after following the above advice and clearing the fault code. You should turn the washing machine off. Disconnect the appliance from your mains supply. Then arrange for an engineer to attend the appliance. You should contact the Baumatic Customer Care Department on (0118) 933 6911.



IF AN ENGINEER ATTENDS DURING THE GUARANTEE PERIOD AND FINDS THAT A FAULT HAS BEEN CAUSED BY AN ITEM ON THE ERROR CODE LIST, WHICH COULD HAVE BEEN CLEARED BY THE CUSTOMER. THEN YOU MAY BE LIABLE FOR THE COST OF THE SERVICE CALL.

General troubleshooting

<i>Problem</i>	<i>Possible solutions</i>
The washing machine does not work.	<ul style="list-style-type: none"> o Close the washing machine's door. o Confirm and press the start button.
Water leakage.	<ul style="list-style-type: none"> o Correctly connect the inlet water pipe.
The spin of the clothes is abnormal.	<ul style="list-style-type: none"> o Reload and distribute the laundry evenly in the drum.
There is a peculiar smell in the washing machine.	<ul style="list-style-type: none"> o Run a high temperature cycle without any clothes.
No water is visible in the drum.	<ul style="list-style-type: none"> o No fault. The water is under the visible area.
There is remaining water in the softener compartment.	<ul style="list-style-type: none"> o No fault. The effect of the softener will not be affected.
The remaining detergent is left on the clothes.	<ul style="list-style-type: none"> o The water-fast component of the non-phosphorus detergent left on the clothes will cause lime scale. Select the rinse and spin program or brush away the detergent when the clothes are dried.
The washing machine does not fill.	<ul style="list-style-type: none"> o Open the water tap. o Check the selection of the program. o Check the water pressure to see if the water pressure is insufficient. o Put through the feed-water. o Close the machine's door. o Check if the inlet water pipe is bent or clogged.
Spinning starts late or the machine does not spin.	<ul style="list-style-type: none"> o The imbalance control system has activated because the laundry is unevenly distributed in the drum, o The appliance will redistribute the laundry by reversing the drum rotation. This may take several attempts before the laundry is evenly distributed and normal spinning can resume. o If the laundry is still not evenly distributed after 10 minutes, the machine will not spin. In the event of this, redistribute the load manually and select the program again.

The washing machine fills and empties at the same time.	<ul style="list-style-type: none"> ○ Make sure the end of the drainage pipe is higher than the water level in the machine. ○ Check if the drainage pipe and sewage have been sealed. If they have been, there will be poor ventilation which causes siphoning.
No drainage of the washing machine.	<ul style="list-style-type: none"> ○ Check if the drainage pump is blocked. ○ Check if the drainage pipe is bent or blocked. ○ Check the height of the drainage nozzle and make sure it is 0.6 – 1 meter from the bottom of the washing machine.
Vibration of the washing machine.	<ul style="list-style-type: none"> ○ Level the appliance. ○ Fasten the footing. ○ Check the transportation bolts have been removed.
The bubbles spill from the detergent drawer.	<ul style="list-style-type: none"> ○ Check if the detergent use is excessive. ○ Put one scoop of softener mixed with ½ litre of water into detergent compartment II. ○ Reduce the usage amount of detergent in the next wash.
The machine stops when the program has not finished.	<ul style="list-style-type: none"> ○ Power failure or water supply cut-off.
The drainage pump makes a noise during operation when the water has just been drained.	<ul style="list-style-type: none"> ○ The inner barrel water of the washing machine has been drained but there is still a small amount of water in the drainage pump and pipe. The drainage pump continuously operates and takes in the air, and at this time there is noise which is normal.
Machine stops for some time during a cycle.	<ul style="list-style-type: none"> ○ The machine adds water automatically. ○ There are too many bubbles in the tube so the machine is cleaning the tube.



IMPORTANT: If your appliance appears not to be operating correctly, then you should disconnect it from your mains supply and then contact the Customer Care Department on telephone number (0118) 933 6911.

DO NOT ATTEMPT TO REPAIR THE APPLIANCE YOURSELF.

Please note that if an engineer is asked to attend whilst the product is under guarantee and finds that the problem is not the result of an appliance fault, then you may be liable for the cost of the call out charge.

The appliance must be accessible for the engineer to perform any necessary repair. If your appliance is installed in such a way that an engineer is concerned that damage will be caused to the appliance or your kitchen, then he will not complete a repair.

This includes situations where appliances have been tiled in, sealed in with sealant, have wooden obstructions placed in front of the appliance, like plinths. Or any installation other than the one specified by Baumatic Ltd. has been completed.

Please refer to the conditions of guarantee that appear on the warranty card that you receive with the appliance.

IMPORTANT: Baumatic Ltd. operates a policy of continuous improvement and reserves the right to adjust and modify its products without prior notification.

Baumatic Consumables

- **BC001** Degreaser for Dishwashers (200 g)
- **BC002** Descaler for Washing Machines and Dishwashers (200 g)
- **BC003** Ceramic Hob Cleaner (250 ml)
- **BC004** Oven Cleaner (250 ml)
- **BC005** Stainless Steel Cleaner and Protector (250 ml)
- **BC007** E-Cloth – General Purpose Cloth
- **BC008** Microwave Cover

To order a Baumatic consumable product please call 0123 5437 244 and quote the product code. You can also order online from eshop.baumatic.co.uk

Technical Data

Manufacturer	BAUMATIC LTD		
Model Number	BWM1406W	/	BFWM1407
Rated Capacity of Standard Cotton Program	6 kg	/	7kg
Energy Efficiency Class	A++		
Annual Energy Consumption (1)	172 kWh	/	196kWh
Energy Consumption of the Standard 60°C Cotton Program at Full Load	0.91 kWh	/	1.02 kWh
Energy Consumption of the Standard 60°C Cotton Program at Partial Load	0.61 kWh	/	0.77 kWh
Energy Consumption of the Standard 40°C Cotton Program at Partial Load	0.61 kWh	/	0.77 kWh
Power Consumption of Off Mode	0.44 W		
Power Consumption of Left-On Mode	0.67 W		
Annual Water Consumption (2)	9900 litres	/	1200 litres
Spin-drying Efficiency Class (3)	C		
Maximum Spin Speed of Standard Cotton Program	1400 rpm		
Remaining Moisture Content of Standard Cotton Program	56 %	/	58%
Standard Cleaning Cycle (4)	Cotton 60°C/40°C		
Program Duration of Standard 60°C Cotton Cycle at Full Load	220 mins	/	200 mins
Program Duration of Standard 60°C Cotton Cycle at Partial Load	160 mins	/	160 mins
Program Duration of Standard 40°C Cotton Cycle at Partial Load	160 mins	/	160 mins
Noise Level	62 db Washing / 78 db Spinning		
Installation Type	Freestanding		

- 1)** Energy consumption is based on 220 standard washing cycles for cotton programmes at 60°C and 40°C at full and partial load, and the consumption of the low-power modes. The actual energy consumption will depend on how the appliance is used.
- 2)** Water consumption is based on 220 standard washing cycles for cotton programmes at 60°C and 40°C at full and partial load. The actual water consumption will depend on how the appliance is used.
- 3)** Spin-drying efficiency is on a scale from G (least efficient) to A (most efficient).
- 4)** These programmes are suitable to clean normally soiled cotton laundry and they are the most efficient programmes in terms of combined energy and water consumption.



United Kingdom

Baumatic Ltd.,
Baumatic Buildings,
6 Bennet Road,
Reading, Berkshire
RG2 0QX
United Kingdom

Sales Telephone

(0118) 933 6900

Sales Fax

(0118) 931 0035

Customer Care Telephone

(0118) 933 6911

Customer Care Fax

(0118) 986 9124

Spares Telephone

(01235) 437244

Advice Line Telephone

(0118) 933 6933

E-mail:

sales@baumatic.co.uk
customercare@baumatic.co.uk
spares@baumatic.co.uk
technical@baumatic.co.uk

Website:

www.baumatic.co.uk

Facebook:

www.facebook.com/baumatic.uk

Republic of Ireland

Service Telephone

1-890 812 724

Spares Telephone

091 756 771

Czech Republic

Baumatic CR s.r.o.
Lípová 665
460 01 Liberec 4
Czech Republic

+420 483 577 200

www.baumatic.cz

Slovakia

Baumatic Slovakia, s.r.o.
Panenská 34
811 03 Bratislava - Staré Mesto
Slovakia

+421 255 640 618

www.baumatic.sk

Germany

Baumatic Gmbh
Bachstr.10-12
D-32 257 Bünde
Deutschland

+49 (0) 5223 99408 0

www.baumatic.de

Italy

Baumatic Italia S.R.L.
Via Galvani N.3
35011 Campodarsego (PD)

+3904 9920 2297

www.baumatic.it

Holland

Baumatic Benelux B.V.
Dukdalfweg 15d
1332 BH ALMERE
Nederland

+31(0)36 549 1553

www.baumatic.nl

